



BELLINI

DESIGN ARCH. LORENZO BELLINI



TABELLA PREZZI FINITURE	pag. 80
INFO TECNICHE	pag. 80
INDICE / INDEX	pag. 82
LAVABO	pag. 86
BIDET	pag. 88
DOCCIA INCASSO	pag. 89
DEVIATORI INCASSO	pag. 90
DOCCIA ESTERNO	pag. 92
VASCA	pag. 92
BAGNO COMPLEMENTI	pag. 94



BELLINI

PREZZO FINITURE

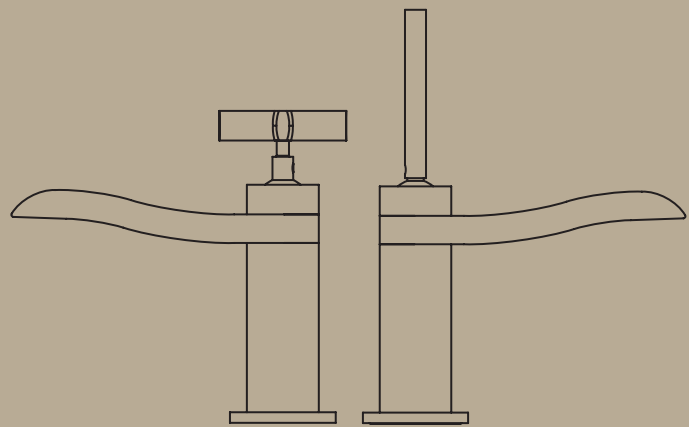
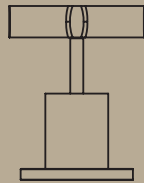
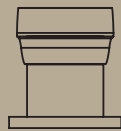
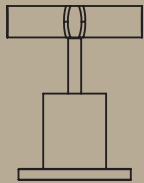
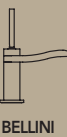
Calcola il prezzo di listino (IVA esclusa) delle finiture diverse dal cromato, consultando la seguente tabella.

Moltiplicare il **PREZZO LISTINO** per il **COEFFICIENTE MOLTIPLICATORE** della finitura scelta, arrotondando per difetto il prezzo ottenuto (eliminare i centesimi).

ESEMPIO per ordinare art. 6305/J/S in finitura dorato: codice **04-6305/J/S-04**

/

PRICE FINISHES

Include the list price (excluding VAT) of different finishes from chrome, consulting the following table. Multiply the **PRICE LIST MULTIPLIER COEFFICIENT** of the chosen finish, reducing the price obtained by deleting the centesim.

EXAMPLE to order art. 6305/J/S gold finish: code **04-6305/J/S-04**

/

FINITURE DI SERIE / STANDARD FINISHES

CODICE CODE	DESCRIZIONE FINITURA FINISH DESCRIPTION	MOLTIPLICATORE MULTIPLIER
01-	cromato / chrome	PREZZO LISTINO°
03-	oro/argento / gold/silver	x
04-	dorato / gold	x
34-	cromo spazzolato / brushing chrome	x
35-	nickel spazzolato / brushing nickel	x
75-	dorato spazzolato / brushing gold	x
87-	oro rosa / pink gold	x
88-	ottone sisal / sisal brass	x

FINITURE A RICHIESTA / ON REQUEST FINISHES

CODICE CODE	DESCRIZIONE FINITURA FINISH DESCRIPTION	MOLTIPLICATORE MULTIPLIER
02-	cromo/oro / chrome/gold	x
05-	bronzo satinato / satin bronze	x
06-	rame vecchio / old copper	x
07-	vecchio argento / old silver	x
08-	canna di fucile / gun barrel	NON REALIZZABILE*
10-	verderame / verdigris	NON REALIZZABILE*
11-	nero antracite / anthracite black	NON REALIZZABILE*
12-	ottone lucido / polished brass	x

°PREZZO DI LISTINO / PRICE LIST

*NON REALIZZABILE / NOT MADE

ATTENZIONE! 13-OTTONE NATURALE e 88-OTTONE SISAL: finiture non protette che antichizzano naturalmente ossidando a contatto con l'umidità atmosferica.
WARNING! 13-NATURAL BRASS and 88-SISAL BRASS: unprotected finishes that naturally oxidise in contact with atmospheric humidity.

PROGETTO SU MISURA: RICHIESTE SPECIALI

I tecnici di Bellosta Rubinetterie sono, inoltre, a disposizione di architetti e designers, per offrire un servizio esclusivo: personalizzazioni di elementi in funzione di specifiche richieste estetiche o problematiche legate a vincoli progettuali, verifica della fattibilità attraverso opportuni studi CAD e sviluppo del disegno tecnico del prodotto speciale richiesto.

Per informazioni e richieste PROGETTI SU MISURA:
 ufficiotecnico@bellostarubinetterie.com



PROGETTO SU MISURA: SPECIAL REQUESTS

Engineers Bellosta Rubinetterie are also available to architects and designers, to offer an exclusive service: customizations of items according to specific aesthetic requirements or issues related to design constraints, verification of the feasibility studies and development through appropriate CAD technical design the required special product. For information and requests "SU MISURA" PROJECTS:
 ufficiotecnico@bellostarubinetterie.com

CONSIGLIO TECNICO

Tutti i miscelatori della collezione BELLINI vengono collaudati nel loro funzionamento al momento dell'assemblaggio. Per garantire la durata delle cartucce nel tempo, si consiglia di spurgare bene l'impianto idraulico prima del montaggio (per rimuovere eventuali detriti) e di installare rubinetti sottolavabo con filtro (art. 020)

N.B.: Qualora il piano lavabo avesse uno spessore superiore a 4 cm specificare la misura al momento dell'ordine.

COMPOSIZIONE CODICE PER ORDINARE ARTICOLO IN FINITURA

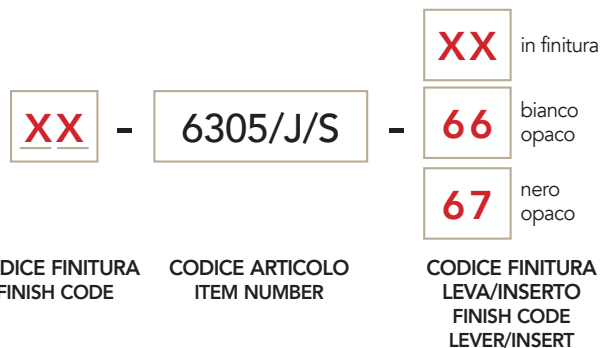

FINITURE A RICHIESTA / ON REQUEST FINISHES

CODICE CODE	DESCRIZIONE FINITURA FINISH DESCRIPTION	MOLTIPLICATORE MULTIPLIER
13-	ottone naturale / natural brass	x
14-	bianco / white	NON REALIZZABILE*
19-	nero / black	NON REALIZZABILE*
28-	nickel satinato / satin nickel	x
30-	nickel lucido / polished nickel	x
33-	cromo satinato / satin chrome	x
56-	avorio / ivory	NON REALIZZABILE*
57-	azzurro / light blue	NON REALIZZABILE*
58-	verdino / light green	NON REALIZZABILE*
59-	marrone / brown	NON REALIZZABILE*
60-	arancio / orange	NON REALIZZABILE*
61-	rosso / red	NON REALIZZABILE*
66-	bianco opaco / mat white	x
67-	nero opaco / mat black	x
68-	rame opaco / mat copper	x
69-	argento opaco / mat silver	x
71-	oro opaco / mat gold	NON REALIZZABILE*
72-	bronzo opaco / mat bronze	x

FORATURA DEI PIANI SANITARI

I miscelatori lavabo/bidet monoforo prevedono un foro di diametro 35 mm nel piano sanitario. Le batterie lavabo 3 fori sono dotate di vitone ceramico destro con apertura a 1/4 di giro (90°); l'interasse consigliato è di 110 mm e foratura come da schema sottostante.

MONOFORO >>

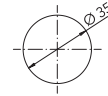

3 FORI >>

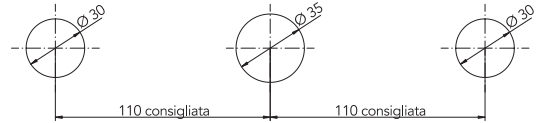

DRILLING PLANS HEALTH

The sink / hole bidet mixers provide a hole diameter of 35 mm in the health plan. The sink batteries 3 holes are equipped with ceramic cartridge Right-open 1/4 turn (90°); the recommended distance is 110 mm, drilling as per the diagram below.

SCHEMA FUNZIONAMENTO DEVIATORI INCASSO 2/3/4 USCITE

Questi deviatori non hanno funzione di chiusura. Ruotando verso destra o sinistra si attivano le uscite. Tra 2 uscite adiacenti durante la rotazione diminuisce la portata dell'uscita iniziale ed incrementa quella della successiva. In posizione intermedia sono entrambe attive a pari portata.



2 OUT

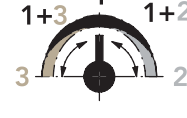

3 OUT



4 OUT

SCHEME OPERATION SWITCHES FLUSH OUTPUT 2/3/4

These diverters have not closing function. By turning to the right or left activates the outputs. Between two adjacent outputs during the rotation decreases the initial output flow and increases that of the next. In position intermediate are both active at the same flow rate.

FUNZIONAMENTO CARTUCCIA JOYSTICK CON LEVA A CROCE

IMPORTANTE! Per il funzionamento NON ruotare la croce. La collezione Bellini nella versione miscelatore con leva a croce, mantiene il medesimo meccanismo joystick di apertura/chiusura e miscelazione acqua calda/fredda.

OPERATION JOYSTICK CARTRIDGE WITH CROSS LEVER

IMPORTANT! For operation does NOT turn the cross. The collection Bellini in mixer version with CROSS lever, maintains the same joystick mechanism of opening / closing and mixing hot / cold water.

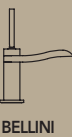
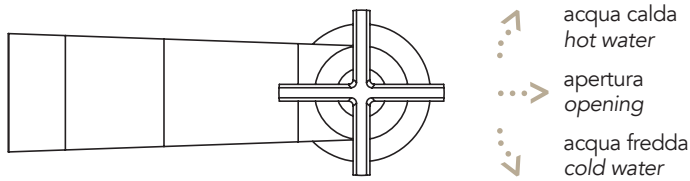

BELLINI

LEVE E INSERTI

Le leve e gli inserti (impugnatura ed erogatore doccetta, deviatore vasca e doccia, leva saliscendi, etc.) della collezione BELLINI sono disponibili, **senza variazione di prezzo**, in:

LEVERS AND INSERTS

Levers and inserts (handle and HAND SHOWER, bath and diverter shower, sliding lever, etc.) of BELLINI collection are available **without price change** in:

SCHEMA DI APERTURA MISCELATORE INCASSO CON MANIGLIA A CROCE
DIAGRAM FOR OPENING BUILT-IN MIXER WITH CROSS HANDLE

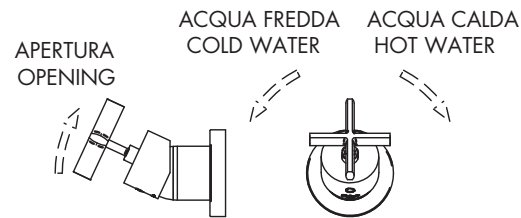

finitura
-XX

bianco opaco
-66

nero opaco
-67



LEGENDA SIMBOLI

ACCESSORI
ACCESSORIES



RICAMBI IMMEDIATI
IMMEDIATE PARTS

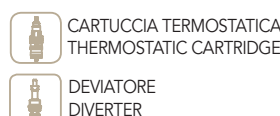
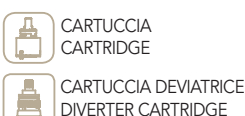

LAVABO

6305/4 pag. 86

BATTERIA LAVABO TRE FORI
3 HOLE BASIN



6305/J/S pag. 86

MISCELATORE LAVABO MONOFORO
BASIN MIXER



6305/JM/S pag. 86

MISCELATORE LAVABO MONOFORO
BASIN MIXER



6305/JP/S pag. 86

MISCELATORE LAVABO MONOFORO BOCCA
PROLUNGATA
BASIN MIXER EXTENDED SPOUT



6305/JMP/S pag. 86

MISCELATORE LAVABO MONOFORO BOCCA
PROLUNGATA
BASIN MIXER EXTENDED SPOUT



446017, 634018, 634019 pag. 87

PROLUNGHE MISCELATORE LAVABO
EXTENSIONS FOR BASIN

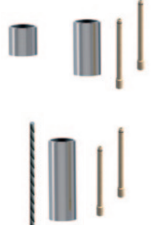

altezza mm 50 / high 50 mm: 446017
altezza mm 100 / high 100 mm: 634018
altezza mm 150 / high 150 mm: 634019

6305/1 pag. 87

MISCELATORE LAVABO ALTO MONOFORO
HIGHER BASIN MIXER



6305/1M pag. 87

MISCELATORE LAVABO ALTO MONOFORO
HIGHER BASIN MIXER



6305/6E + 634024 pag. 87

GRUPPO LAVABO DA PARETE
WALL BASIN MOUNTED GROUP



parti esterne / external parts: 6305/6E
parte incasso / built-in part: 634024



6305/3/AE + 774057 pag. 87

MISCELATORE LAVABO DA PARETE
WALL BASIN MIXER



parti esterne / external parts: 6305/3/AE
parte incasso / built-in part: 774057



6305/3M/AE + 774057 pag. 88

MISCELATORE LAVABO DA PARETE
WALL BASIN MIXER



parti esterne / external parts: 6305/3M/AE
parte incasso / built-in part: 774057



6305/R/BE + 104033 pag. 88

MISCELATORE INCASSO REMOTO
BUILT-IN REMOTE MIXER



parti esterne / external parts: 6305/R/BE
parte incasso / built-in part: 104033



6305/R/BME+104033 pag. 88

MISCELATORE INCASSO REMOTO
BUILT-IN REMOTE MIXER



parti esterne / external parts: 6305/R/BME
parte incasso / built-in part: 104033



BIDET

6307/7 pag. 88

BATTERIA BIDET TRE FORI
3 HOLE BIDET



6307/J/S pag. 88

MISCELATORE BIDET MONOFORO
BIDET MIXER



BIDET



6307/JM/S pag. **89**

MISCELATORE BIDET MONOFORO
BIDET MIXER

DOCCIA INCASSO



6300/3E + 634031 pag. **89**

GRUPPO INCASSO C/DEVIATORE 2 USCITE
BUILT-IN GROUP WITH 2 OUT DIVERTER



parti esterne / external parts: 6300/3E
parte incasso / built-in part: 634031



6305/R/BE + 104033 pag. **89**

MISCELATORE INCASSO REMOTO
BUILT-IN REMOTE MIXER

parti esterne / external parts: 6305/R/BE
parte incasso / built-in part: 104033



6305/R/BME + 104033 pag. **89**

MISCELATORE INCASSO REMOTO
BUILT-IN REMOTE MIXER



parti esterne / external parts: 6305/R/BME
parte incasso / built-in part: 104033



6300/E + 104002 pag. **89**

MISCELATORE INCASSO C/DEVIATORE 2 USCITE
BUILT-IN MIXER WITH DIVERTER 2 OUT



parti esterne / external parts: 6300/E
parte incasso / built-in part: 104002



6300/ME + 104002 pag. **90**

MISCELATORE INCASSO C/DEVIATORE 2 USCITE
BUILT-IN MIXER WITH DIVERTER 2 OUT



parti esterne / external parts: 6300/ME
parte incasso / built-in part: 104002



6300/1/PE + 724027 pag. **90**

MISCELATORE INCASSO C/DEVIATORE E DOCCINO
BUILT-IN MIXER WITH DIVERTER AND HAND SHOWER

parti esterne / external parts: 6300/1/PE
parte incasso / built-in part: 724027



6300/1/PME + 724027 pag. **90**

MISCELATORE INCASSO C/DEVIATORE E DOCCINO
BUILT-IN MIXER WITH DIVERTER AND HAND SHOWER

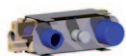

parti esterne / external parts: 6300/1/PME
parte incasso / built-in part: 724027

DEVIATORI INCASSO



6303/2/1E + 914016 pag. **90**

DEVIATORE INCASSO 2 USCITE
BUILT-IN DIVERTER 2 OUT



parti esterne / external parts: 6303/2/1E
parte incasso / built-in part: 914016



6303/2/1ME + 914016 pag. **90**

DEVIATORE INCASSO 2 USCITE
BUILT-IN DIVERTER 2 OUT



parti esterne / external parts: 6303/2/1ME
parte incasso / built-in part: 914016



6303/3/1E + 034127 pag. **91**

DEVIATORE INCASSO 3 USCITE
BUILT-IN DIVERTER 3 OUT



parti esterne / external parts: 6303/3/1E
parte incasso / built-in part: 034127



6303/3/1ME + 034127 pag. **91**

DEVIATORE INCASSO 3 USCITE
BUILT-IN DIVERTER 3 OUT



parti esterne / external parts: 6303/3/1ME
parte incasso / built-in part: 034127



6303/4/1E + 034128 pag. **91**

DEVIATORE INCASSO 4 USCITE
BUILT-IN DIVERTER 4 OUT



parti esterne / external parts: 6303/4/1E
parte incasso / built-in part: 034128



6303/4/1ME + 034128 pag. **91**

DEVIATORE INCASSO 4 USCITE
BUILT-IN DIVERTER 4 OUT



parti esterne / external parts: 6303/4/1ME
parte incasso / built-in part: 034128

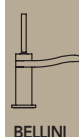

DOCCIA INCASSO TERMOSTATICO



6312/PE+484020 pag. 248*

MISCELATORE TERMOSTATICO INCASSO 1 USCITA
BUILT-IN THERMOSTATIC MIXER 1 OUT

parti esterne / external parts: 6312/PE
parte incasso / built-in part: 484020



6312/PME+484020 pag. 249*

MISCELATORE TERMOSTATICO INCASSO 1 USCITA
BUILT-IN THERMOSTATIC MIXER 1 OUT

parti esterne / external parts: 6312/PME
parte incasso / built-in part: 484020



6312/2/PE+484021 pag. 249*

MISCELATORE TERMOSTATICO INCASSO 2 USCITE
BUILT-IN THERMOSTATIC MIXER WITH DIVERTER
2 OUT

parti esterne / external parts: 6312/2/PE
parte incasso / built-in part: 484021



6312/2/PME+484021 pag. 249*

MISCELATORE TERMOSTATICO INCASSO 2 USCITE
BUILT-IN THERMOSTATIC MIXER WITH DIVERTER
2 OUT

parti esterne / external parts: 6312/2/PME
parte incasso / built-in part: 484021



6312/3/PE+484022 pag. 249*

MISCELATORE TERMOSTATICO INCASSO 3 USCITE
BUILT-IN THERMOSTATIC MIXER WITH DIVERTER
3 OUT

parti esterne / external parts: 6312/3/PE
parte incasso / built-in part: 484022



6312/3/PME+484022 pag. 249*

MISCELATORE TERMOSTATICO INCASSO 3 USCITE
BUILT-IN THERMOSTATIC MIXER WITH DIVERTER
3 OUT

parti esterne / external parts: 6312/3/PME
parte incasso / built-in part: 484022



6312/4/PE+484023 pag. 250*

MISCELATORE TERMOSTATICO INCASSO 4 USCITE
BUILT-IN THERMOSTATIC MIXER WITH DIVERTER
4 OUT

parti esterne / external parts: 6312/4/PE
parte incasso / built-in part: 484023



6312/4/PME+484023 pag. 250*

MISCELATORE TERMOSTATICO INCASSO 4 USCITE
BUILT-IN THERMOSTATIC MIXER WITH DIVERTER
4 OUT

parti esterne / external parts: 6312/4/PME
parte incasso / built-in part: 484023

DOCCIA ESTERNO



6309/1 pag. 92

GRUPPO DOCCIA ESTERNO
EXTERNAL SHOWER GROUP



6309/5/1 pag. 92

GRUPPO DOCCIA ESTERNO C/STELO COMPLETO
EXTERNAL SHOWER GROUP WITH COMPLETE PIPE



6309/1A pag. 92

MISCELATORE DOCCIA ESTERNO
EXTERNAL SHOWER MIXER



6309/5/1A pag. 92

MISCELATORE DOCCIA ESTERNO C/STELO COMPLETO
EXTERNAL SHOWER GROUP WITH COMPLETE PIPE

DOCCIA COMPLEMENTI



6303/1/A pag. 136*

SUPPORTO DOCCIA COMPLETO
FULL SHOWER SUPPORT



6330 pag. 143*

SALISCENDI COMPLETO C/PRESA D'ACQUA
COMPLETE WALL PIPE WITH WATER CONNECTION



6330/1 pag. 148*

ASTA SALISCENDI
WALL PIPE



6313/5/1 pag. 152*

CURVA PRESA ACQUA C/STELO COMPLETO
CURVE WATER CONNECTOR WITH COMPLETE ROD

DOCCIA COMPLEMENTI



635009 pag. 103*
 SOFFIONE DOCCIA Ø305 OTTONE
 BRASS CEILING SHOWER Ø305



884055 pag. 111*
 BRACCIO DOCCIA DA PARETE
 WALL SHOWER ARM

VASCA



6301/6 pag. 92
 GRUPPO VASCA ESTERNO
 EXTERNAL BATH GROUP



6301/A pag. 93
 MISCELATORE VASCA ESTERNO
 EXTERNAL BATH MIXER



6301/2/M pag. 93
 BATTERIA PER BORDO VASCA
 BATH RIM



6301/2/A pag. 93
 MISCELATORE PER BORDO VASCA
 BATH RIM MIXER



6301/26 pag. 93
 GRUPPO VASCA C/RACCORDI A PAVIMENTO
 FLOOR BATH GROUP



6303 pag. 93
 BOCCA VASCA DA PARETE
 WALL BATH SPOUT

BAGNO COMPLEMENTI



6308/ME + 604003 pag. 94
 RUBINETTO D'ARRESTO 1/2"
 BUILT-IN STOP COCK 1/2"



parti esterne / external parts: 6308/ME
 parte incasso / built-in part: 604003



6308/ME + 604005 pag. 94
 RUBINETTO D'ARRESTO 3/4"
 BUILT-IN STOP COCK 3/4"



parti esterne / external parts: 6308/ME
 parte incasso / built-in part: 604005



6308/E + 054025 o 054026 pag. 94
 RUBINETTO D'ARRESTO 1/2"
 BUILT-IN STOP COCK 1/2"



parti esterne / external parts: 6308/E
 parte incasso / built-in part: 054025 DX o 054026 SX



6308/E + 054027 o 054028 pag. 94
 RUBINETTO D'ARRESTO 3/4"
 BUILT-IN STOP COCK 3/4"



parti esterne / external parts: 6308/E
 parte incasso / built-in part: 054027 DX o 054028 SX

* **ABBINAMENTO CONSIGLIATO:** PER PREZZI E SCHEDE TECNICHE, VEDI RIFERIMENTO PAGINA LISTINO REVIVRE
 * **RECOMMENDED COMBINATION:** FOR PRICES AND TECHNICAL DETAILS, SEE PAGE REFERENCE PRICE REVIVRE

6305/4

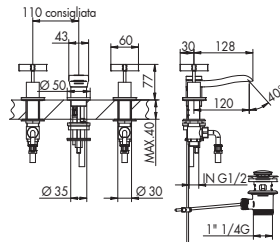

BATTERIA LAVABO TRE FORI

- > vitone ceramico 90°
- > uscita libera senza areatore
- > interasse bocca 120 mm
- > limitatore di portata 5l/min 3bar per ingresso
- > senza flessibili di alimentazione
- > con scarico
- > maniglia a croce

605007
p. 151

CROMATO

01-6305/4

€

ALTRE FINITURE

XX-6305/4

€

6305/J/S

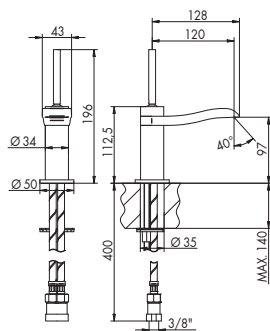

MISCELATORE LAVABO MONOFORO

- > cartuccia tipo joystick
- > uscita libera senza areatore
- > interasse bocca 120 mm
- > limitatore di portata 5l/min 3bar per ingresso
- > flessibili di alimentazione
- > senza scarico
- > leva joystick a stilo (vedi pag. 81)

0136 - 0136/1
p. 717

634011
p. 150

CROMATO

01-6305/J/S-01

leva in finitura

€

01-6305/J/S-66

leva bianco op.

€

01-6305/J/S-67

leva nero op.

€

ALTRE FINITURE

XX-6305/J/S-XX

leva in finitura

€

XX-6305/J/S-66

leva bianco op.

€

XX-6305/J/S-67

leva nero op.

€

6305/JM/S

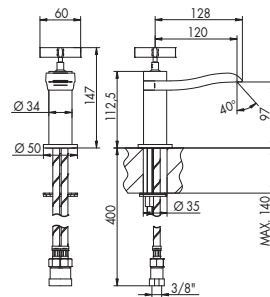

MISCELATORE LAVABO MONOFORO

- > cartuccia tipo joystick
- > uscita libera senza areatore
- > interasse bocca 120 mm
- > limitatore di portata 5l/min 3bar per ingresso
- > flessibili di alimentazione
- > senza scarico
- > leva joystick a croce

0136 - 0136/1
p. 717

634011
p. 150

CROMATO

01-6305/JM/S

€

ALTRE FINITURE

XX-6305/JM/S

€

6305/JP/S

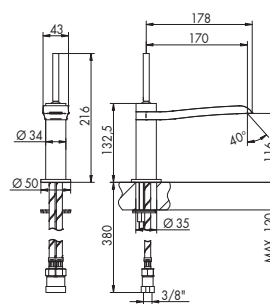

MISCELATORE LAVABO MONOFORO BOCCA PROLUNGATA

- > cartuccia tipo joystick
- > uscita libera senza areatore
- > interasse bocca 170 mm
- > limitatore di portata 5l/min 3bar per ingresso
- > flessibili di alimentazione
- > senza scarico
- > leva joystick a stilo (vedi pag. 81)

0136 - 0136/1
p. 717

634011
p. 150

CROMATO

01-6305/JP/S-01

leva in finitura

€

01-6305/JP/S-66

leva bianco op.

€

01-6305/JP/S-67

leva nero op.

€

ALTRE FINITURE

XX-6305/JP/S-XX

leva in finitura

€

XX-6305/JP/S-66

leva bianco op.

€

XX-6305/JP/S-67

leva nero op.

€

6305/JMP/S

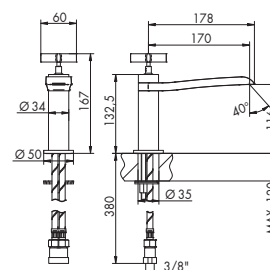

MISCELATORE LAVABO MONOFORO BOCCA PROLUNGATA

- > cartuccia tipo joystick
- > uscita libera senza areatore
- > interasse bocca 170 mm
- > limitatore di portata 5l/min 3bar per ingresso
- > flessibili di alimentazione
- > senza scarico
- > leva joystick a croce

0136 - 0136/1
p. 717

634011
p. 150

CROMATO

01-6305/JMP/S

€

ALTRE FINITURE

XX-6305/JMP/S

€

446017 | 634018 | 634019

PROLUNGHE MISCELATORE LAVABO

- > diametro 34 mm
- > altezza 50 mm, 100 mm, 150 mm

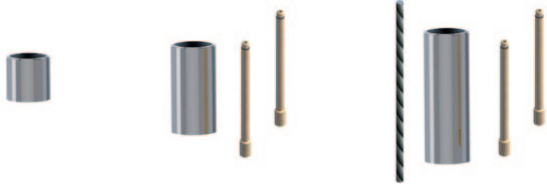

CROMATO

01-446017	50 mm	€
01-634018	100 mm	€
01-634019	150 mm	€

ALTRE FINITURE

XX-446017	50 mm	€
XX-634018	100 mm	€
XX-634019	150 mm	€

6305/1

MISCELATORE LAVABO ALTO MONOFORO

- > cartuccia tipo joystick
- > uscita libera senza areatore
- > interasse bocca 170 mm
- > limitatore di portata 5l/min 3bar per ingresso
- > flessibili di alimentazione
- > senza scarico
- > leva joystick a stilo (vedi pag. 81)

 0136 - 0136/1
p. 717

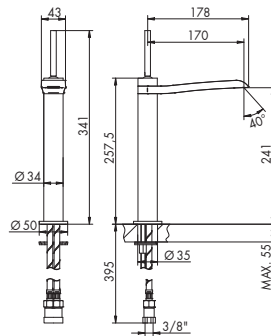
 634011
p. 150

CROMATO

01-6305/1-01	leva in finitura	€
01-6305/1-66	leva bianco op.	€
01-6305/1-67	leva nero op.	€

ALTRE FINITURE

XX-6305/1-XX	leva in finitura	€
XX-6305/1-66	leva bianco op.	€
XX-6305/1-67	leva nero op.	€

6305/1M

MISCELATORE LAVABO ALTO MONOFORO

- > cartuccia tipo joystick
- > uscita libera senza areatore
- > interasse bocca 170 mm
- > limitatore di portata 5l/min 3bar per ingresso
- > flessibili di alimentazione
- > senza scarico
- > leva joystick a croce

 0136 - 0136/1
p. 717

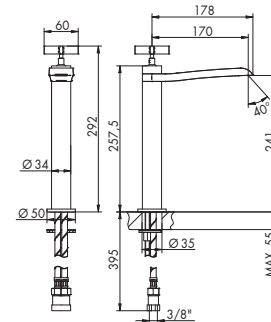
 634011
p. 150

CROMATO

01-6305/1M		€
------------	--	---

ALTRE FINITURE

XX-6305/1M		€
------------	--	---

6305/6E + 634024

GRUPPO LAVABO DA PARETE

- > vitone ceramico 90°
- > uscita libera senza areatore
- > interasse bocca 170 mm
- > limitatore di portata 8l/min 3bar
- > ingressi da 1/2"
- > senza scarico
- > maniglia a croce

 0136 - 0136/1
p. 717

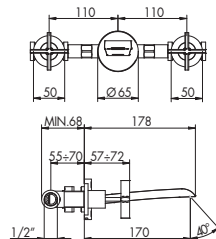
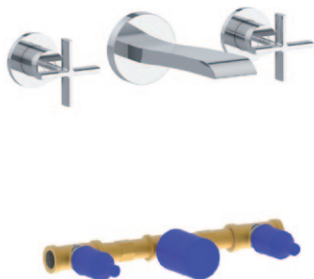
 605007
p. 151

PARTI ESTERNE - CROMATO

01-6305/6E		€
------------	--	---

PARTI ESTERNE - ALTRE FINITURE

XX-6305/6E		€
------------	--	---

PARTE INCASSO

634024	info pag. 31	€
--------	--------------	---

PREZZO TOTALE

		€
--	--	---

6305/3/AE + 774057

MISCELATORE LAVABO DA PARETE

- > cartuccia tradizionale
- > uscita libera senza areatore
- > interasse bocca 170 mm
- > limitatore di portata 8 l/min 3bar
- > ingressi da 1/2"
- > senza scarico
- > leva a stilo (vedi pag. 81)

 0136 - 0136/1
p. 717

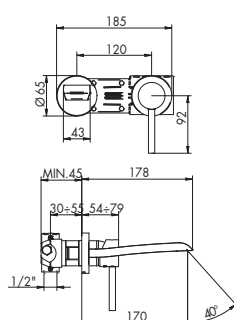
 025002
p. 149

PARTI ESTERNE - CROMATO

01-6305/3/AE-01	leva in finitura	€
01-6305/3/AE-66	leva bianco op.	€
01-6305/3/AE-67	leva nero op.	€

PARTI ESTERNE - ALTRE FINITURE

XX-6305/3/AE-XX	leva in finitura	€
XX-6305/3/AE-66	leva bianco op.	€
XX-6305/3/AE-67	leva nero op.	€

PARTE INCASSO

01-774057	info pag. 33	€
-----------	--------------	---

PREZZO TOTALE

		€
--	--	---

ACCESSORI



RICAMBI IMMEDIATI



XX = CODICE FINITURA RICHIESTA: per identificare codice corretto vedi pag. 80
M* = MOLTIPLICATORE: per calcolare il prezzo delle altre finiture vedi tabella pag. 80

6305/3M/AE + 774057

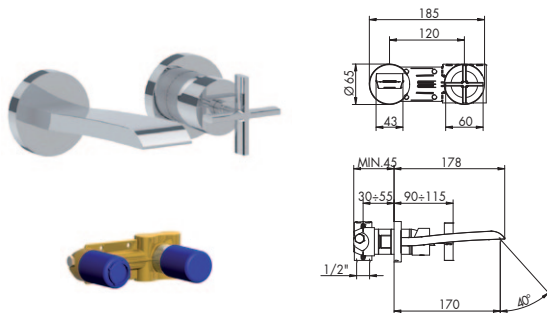

MISCELATORE LAVABO DA PARETE

- > cartuccia tradizionale
- > uscita libera senza areatore
- > interasse bocca 170 mm
- > limitatore di portata 8 l/min 3bar
- > ingressi da 1/2"
- > senza scarico
- > maniglia a croce

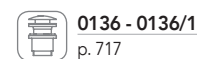

PARTI ESTERNE - CROMATO

01-6305/3M/AE €

PARTI ESTERNE - ALTRE FINITURE

XX-6305/3M/AE €

PARTE INCASSO

01-774057 info pag. 33 €

PREZZO TOTALE €

6305/R/BE + 104033

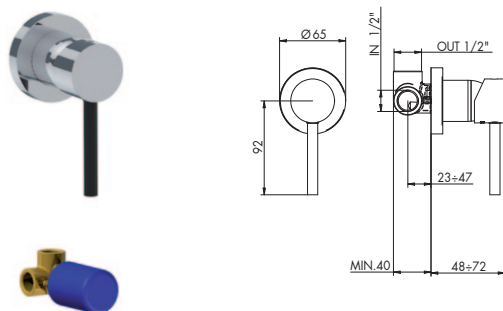

MISCELATORE INCASSO REMOTO

- > cartuccia tradizionale
- > ingressi da 1/2"
- > uscita superiore
- > senza scarico
- > leva a stilo (vedi pag. 81)

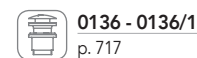

PARTI ESTERNE - CROMATO

01-6305/R/BE-01 leva in finitura €

01-6305/R/BE-66 leva bianco op. €

01-6305/R/BE-67 leva nero op. €

PARTI ESTERNE - ALTRE FINITURE

XX-6305/R/BE-XX leva in finitura €

XX-6305/R/BE-66 leva bianco op. €

XX-6305/R/BE-67 leva nero op. €

PARTE INCASSO

01-104033 info pag. 32 €

PREZZO TOTALE €

6305/R/BME + 104033

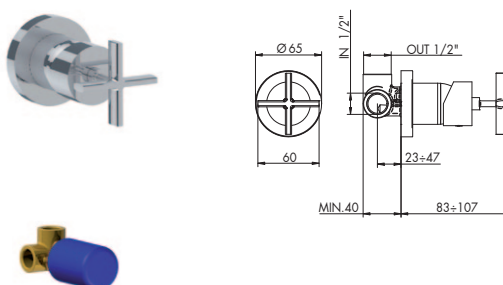

MISCELATORE INCASSO REMOTO

- > cartuccia tradizionale
- > ingressi da 1/2"
- > uscita superiore
- > senza scarico
- > maniglia a croce

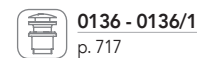

PARTI ESTERNE - CROMATO

01-6305/R/BME €

PARTI ESTERNE - ALTRE FINITURE

XX-6305/R/BME €

PARTE INCASSO

01-104033 info pag. 32 €

PREZZO TOTALE €

6307/7

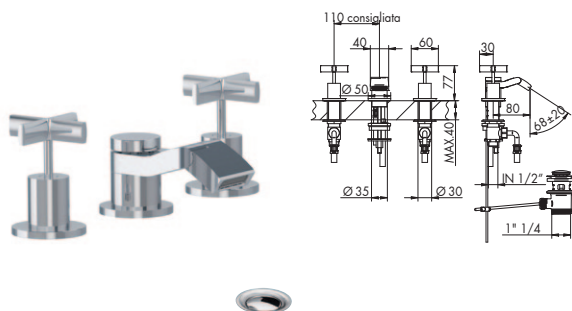

BATTERIA BIDET TRE FORI

- > vitone ceramico 90°
- > interasse bocca 80 mm
- > aeratore snodato
- > senza flessibili di alimentazione
- > con scarico
- > maniglia a croce



CROMATO

01-6307/7 €

ALTRE FINITURE

XX-6307/7 €

6307/J/S

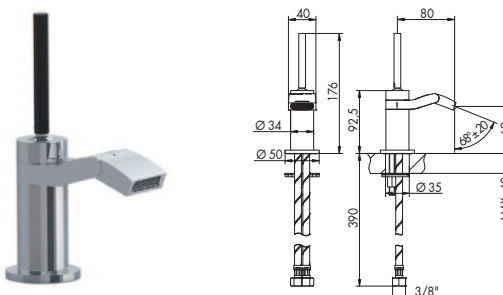

MISCELATORE BIDET MONOFORO

- > cartuccia tipo joystick
- > interasse bocca 80 mm
- > aeratore snodato
- > flessibili di alimentazione
- > senza scarico
- > leva joystick a stilo (vedi pag. 81)

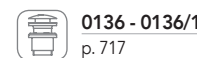

CROMATO

01-6307/J/S-01 leva in finitura €

01-6307/J/S-66 leva bianco op. €

01-6307/J/S-67 leva nero op. €

ALTRE FINITURE

XX-6307/J/S-XX leva in finitura €

XX-6307/J/S-66 leva bianco op. €

XX-6307/J/S-67 leva nero op. €

6307/JM/S

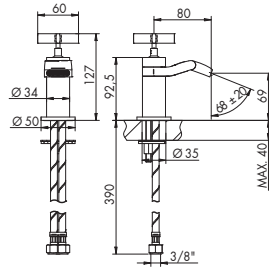

MISCELATORE BIDET MONOFORO

- > cartuccia tipo joystick
- > interasse bocca 80 mm
- > aeratore snodato
- > flessibili di alimentazione
- > senza scarico
- > leva joystick a croce

- 0136 - 0136/1 p. 717
- 634011 p. 150
- 795004 p. 142

CROMATO	
01-6307/JM/S	€

ALTRE FINITURE	
XX-6307/JM/S	€

6300/3E + 634031

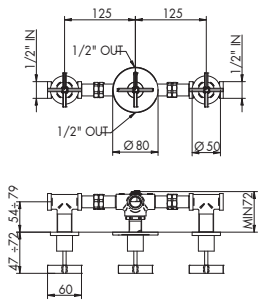
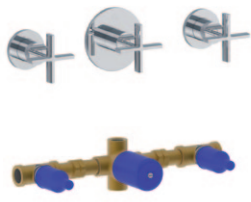

GRUPPO INCASSO C/DEVIATORE 2 USCITE

- > vitone ceramico 90°
- > deviatore a dischi ceramici 2 uscite senza chiusura
- > attacchi da 1/2"
- > maniglia a croce

- 605007 p. 151
- 635010 p. 131

PARTI ESTERNE - CROMATO	
01-6300/3E	€

PARTI ESTERNE - ALTRE FINITURE	
XX-6300/3E	€

PARTE INCASSO	
634031	info pag. 36 €

PREZZO TOTALE	
	€

6305/R/BE + 104033

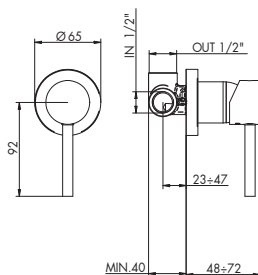

MISCELATORE INCASSO REMOTO

- > cartuccia tradizionale
- > ingressi da 1/2"
- > uscita superiore
- > senza scarico
- > leva a stilo (vedi pag. 81)

- 025002 p. 149

PARTI ESTERNE - CROMATO	
01-6305/R/BE-01	leva in finitura €
01-6305/R/BE-66	leva bianco op. €
01-6305/R/BE-67	leva nero op. €

PARTI ESTERNE - ALTRE FINITURE	
XX-6305/R/BE-XX	leva in finitura €
XX-6305/R/BE-66	leva bianco op. €
XX-6305/R/BE-67	leva nero op. €

PARTE INCASSO	
01-104033	info pag. 32 €

PREZZO TOTALE	
	€

6305/R/BME + 104033

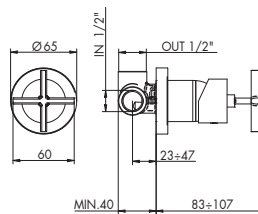

MISCELATORE INCASSO REMOTO

- > cartuccia tradizionale
- > ingressi da 1/2"
- > uscita superiore
- > senza scarico
- > maniglia a croce

- 025002 p. 149

PARTI ESTERNE - CROMATO	
01-6305/R/BME	€

PARTI ESTERNE - ALTRE FINITURE	
XX-6305/R/BME	€

PARTE INCASSO	
01-104033	info pag. 32 €

PREZZO TOTALE	
	€

6300/E + 104002

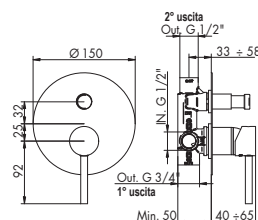

MISCELATORE INCASSO C/DEVIATORE 2 USCITE

- > cartuccia tradizionale
- > deviatore a pressione 2 uscite c/ritorno automatico e blocco meccanico basse pressioni
- > attacchi da 1/2"
- > uscita principale inferiore da 3/4"
- > incasso c/b-box
- > leva a stilo (vedi pag. 81)

- 025002 p. 149
- 105029 p. 131

PARTI ESTERNE - CROMATO	
01-6300/E-01	leva in finitura €
01-6300/E-66	leva bianco op. €
01-6300/E-67	leva nero op. €

PARTI ESTERNE - ALTRE FINITURE	
XX-6300/E-XX	leva in finitura €
XX-6300/E-66	leva bianco op. €
XX-6300/E-67	leva nero op. €

PARTE INCASSO	
01-104002	info pag. 37 €

PREZZO TOTALE	
	€

ACCESSORI



RICAMBI IMMEDIATI



XX = CODICE FINITURA RICHIESTA: per identificare codice corretto vedi pag. 80
 M* = MOLTIPLICATORE: per calcolare il prezzo delle altre finiture vedi tabella pag. 80

6300/ME + 104002

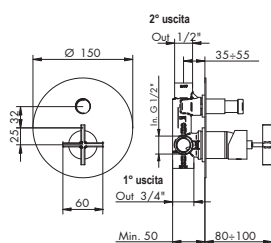

MISCELATORE INCASSO C/DEVIATORE 2 USCITE

- > cartuccia tradizionale
- > deviatore a pressione 2 uscite c/ritorno automatico e blocco meccanico basse pressioni
- > attacchi da 1/2" > uscita principale inferiore da 3/4"
- > incasso c/b-box > maniglia a croce

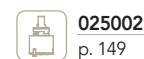

PARTI ESTERNE - CROMATO

01-6300/ME €

PARTI ESTERNE - ALTRE FINITURE

XX-6300/ME €

PARTE INCASSO

01-104002 info pag. 37 €

PREZZO TOTALE €

6300/1/PE + 724027

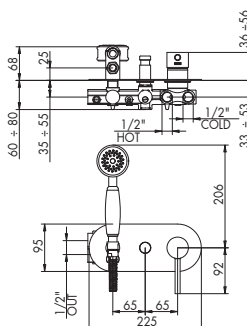

MISCELATORE INCASSO C/DEVIATORE E DOCCINO

- > cartuccia tradizionale
- > deviatore a pressione 2 uscite c/ritorno automatico e blocco meccanico basse pressioni
- > attacchi da 1/2" > flessibile in metallo 150 cm
- > uscita principale fianco sinistro > leva a stilo (vedi pag. 81)



PARTI ESTERNE - CROMATO

01-6300/1/PE-01 leva+ins. in finitura €

01-6300/1/PE-66 leva+ins. bianco op. €

01-6300/1/PE-67 leva+ins. nero op. €

PARTI ESTERNE - ALTRE FINITURE

XX-6300/1/PE-XX leva+ins. in finitura €

XX-6300/1/PE-66 leva+ins. bianco op. €

XX-6300/1/PE-67 leva+ins. nero op. €

PARTE INCASSO

01-724027 info pag. 38 €

PREZZO TOTALE €

6300/1/PME + 724027

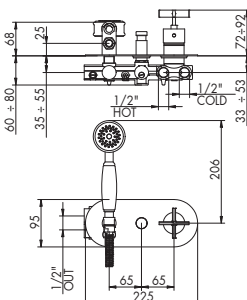

MISCELATORE INCASSO C/DEVIATORE E DOCCINO

- > cartuccia tradizionale
- > deviatore a pressione 2 uscite c/ritorno automatico e blocco meccanico basse pressioni
- > attacchi da 1/2" > flessibile in metallo 150 cm
- > uscita principale fianco sinistro > maniglia a croce



PARTI ESTERNE - CROMATO

01-6300/1/PME-01 ins. in finitura €

01-6300/1/PME-66 ins. bianco op. €

01-6300/1/PME-67 ins. nero op. €

PARTI ESTERNE - ALTRE FINITURE

XX-6300/1/PME-XX ins. in finitura €

XX-6300/1/PME-66 ins. bianco op. €

XX-6300/1/PME-67 nero op. €

PARTE INCASSO

01-724027 info pag. 38 €

PREZZO TOTALE €

6303/2/1E + 914016

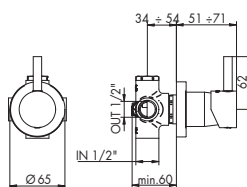

DEVIATORE INCASSO 2 USCITE

- > deviatore a dischi ceramici 2 uscite senza chiusura
- > attacchi da 1/2"
- > leva a stilo (vedi pag. 81)



PARTI ESTERNE - CROMATO

01-6303/2/1E-01 leva in finitura €

01-6303/2/1E-66 leva bianco op. €

01-6303/2/1E-67 leva nero op. €

PARTI ESTERNE - ALTRE FINITURE

XX-6303/2/1E-XX leva in finitura €

XX-6303/2/1E-66 leva bianco op. €

XX-6303/2/1E-67 leva nero op. €

PARTE INCASSO

914016 info pag. 38 €

PREZZO TOTALE €

6303/2/1ME + 914016

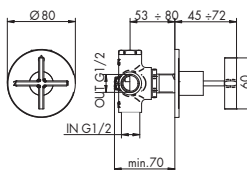

DEVIATORE INCASSO 2 USCITE

- > deviatore a dischi ceramici 2 uscite senza chiusura
- > attacchi da 1/2"
- > maniglia a croce



PARTI ESTERNE - CROMATO

01-6303/2/1ME €

PARTI ESTERNE - ALTRE FINITURE

XX-6303/2/1ME €

PARTE INCASSO

914016 info pag. 38 €

PREZZO TOTALE €



CARTUCCIA



DEVIATORE



CARTUCCIA DEVIATRICE

6303/3/1E + 034127

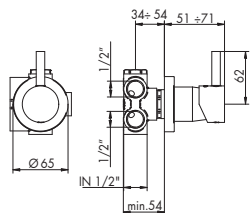

DEVIATORE INCASSO 3 USCITE

> deviatore a dischi ceramici 3 uscite senza chiusura
 > attacchi da 1/2"
 > leva a stilo (vedi pag. 81)



PARTI ESTERNE - CROMATO		
01-6303/3/1E-01	leva in finitura	€
01-6303/3/1E-66	leva bianco op.	€
01-6303/3/1E-67	leva nero op..	€
PARTE INCASSO		
034127	info pag. 38	€
PREZZO TOTALE		€

PARTI ESTERNE - ALTRE FINITURE		
XX-6303/3/1E-XX	leva in finitura	€
XX-6303/3/1E-66	leva bianco op.	€
XX-6303/3/1E-67	leva nero op.	€

6303/3/1ME + 034127

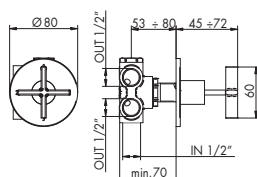

DEVIATORE INCASSO 3 USCITE

> deviatore a dischi ceramici 3 uscite senza chiusura
 > attacchi da 1/2"
 > maniglia a croce



PARTI ESTERNE - CROMATO		
01-6303/3/1ME		€
PARTE INCASSO		
034127	info pag. 38	€
PREZZO TOTALE		€

PARTI ESTERNE - ALTRE FINITURE		
XX-6303/3/1ME		€

6303/4/1E + 034128

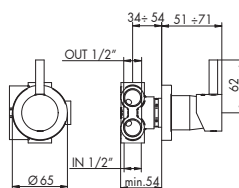

DEVIATORE INCASSO 4 USCITE

> deviatore a dischi ceramici 4 uscite senza chiusura
 > attacchi da 1/2"
 > leva a stilo (vedi pag. 81)



PARTI ESTERNE - CROMATO		
01-6303/4/1E-01	leva in finitura	€
01-6303/4/1E-66	leva bianco op.	€
01-6303/4/1E-67	leva nero op.	€
PARTE INCASSO		
034128	info pag. 38	€
PREZZO TOTALE		€

PARTI ESTERNE - ALTRE FINITURE		
XX-6303/4/1E-XX	leva in finitura	€
XX-6303/4/1E-66	leva bianco op.	€
XX-6303/4/1E-67	leva nero op.	€

6303/4/1ME + 034128

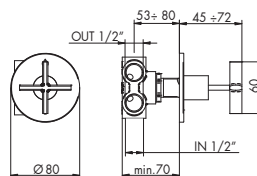

DEVIATORE INCASSO 4 USCITE

> deviatore a dischi ceramici 4 uscite senza chiusura
 > attacchi da 1/2"
 > maniglia a croce



PARTI ESTERNE - CROMATO		
01-6303/4/1ME		€
PARTE INCASSO		
034128	info pag. 38	€
PREZZO TOTALE		€

PARTI ESTERNE - ALTRE FINITURE		
XX-6303/4/1ME		€

I DOCCIA INCASSO TERMOSTATICO CONSIGLIATI SONO PRESENTI SU LISTINO REVIVRE

6312/PE + 484020	6312/PME + 484020
6312/2/PE + 484021	6312/2/PME + 484021
6312/3/PE + 484022	6312/3/PME + 484022
6312/4/PE + 484023	6312/4/PME + 484023

I DOCCIA COMPLEMENTI CONSIGLIATI SONO PRESENTI SU LISTINO REVIVRE

6303/1/A	635009
6330	884055
6330/1	
6313/5/1	

RICAMBI IMMEDIATI



XX = CODICE FINITURA RICHIESTA: per identificare codice corretto vedi pag. 80
M* = MOLTIPLICATORE: per calcolare il prezzo delle altre finiture vedi tabella pag. 80

6309/1

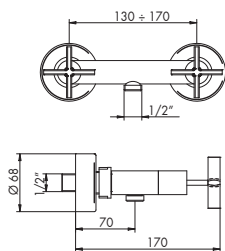

GRUPPO DOCCIA ESTERNO

- > vitone ceramico 90°
- > senza set doccia
- > attacchi da 1/2"
- > maniglia a croce

605007
p. 151

CROMATO

01-6309/1

€

ALTRE FINITURE

XX-6309/1

€

6309/5/1

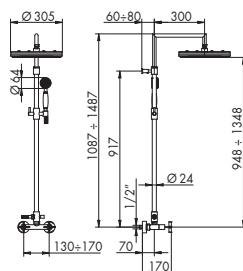

GRUPPO DOCCIA ESTERNO C/STELO COMPLETO

- > vitone ceramico 90°
- > deviatore a trazione c/ritorno automatico
- > stelo regolabile
- > soffione ottone Ø305
- > doccetta monogetto in metallo (vedi pag. 81)
- > flessibile in metallo 150 cm
- > supporto doccetta scorrevole
- > attacchi da 1/2"
- > maniglia a croce

605007
p. 151

CROMATO

01-6309/5/1-01

leva+ins. in finitura

€

01-6309/5/1-66

leva+ins. bianco op.

€

01-6309/5/1-67

leva+ins. nero op.

€

ALTRE FINITURE

XX-6309/5/1-XX

leva+ins. in finitura €

XX-6309/5/1-66

leva+ins. bianco op. €

XX-6309/5/1-67

leva+ins. nero op. €

6309/1A

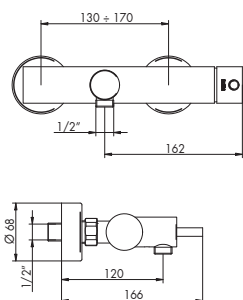

MISCELATORE DOCCIA ESTERNO

- > cartuccia tradizionale
- > senza set doccia
- > attacchi da 1/2"
- > leva a stilo (vedi pag. 81)

025002
p. 149

CROMATO

01-6309/1A-01

leva in finitura

€

01-6309/1A-66

leva bianco op.

€

01-6309/1A-67

leva nero op.

€

ALTRE FINITURE

XX-6309/1A-XX

leva in finitura €

XX-6309/1A-66

leva bianco op. €

XX-6309/1A-67

leva nero op. €

6309/5/1A

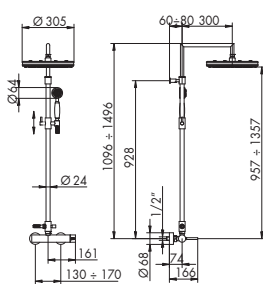

MISCELATORE DOCCIA ESTERNO C/STELO

- > cartuccia tradizionale
- > stelo regolabile
- > deviatore a trazione c/ritorno automatico
- > soffione ottone Ø305
- > doccetta in metallo
- > flessibile in metallo 150 cm
- > supporto doccetta scorrevole
- > attacchi da 1/2"
- > leva a stilo (vedi pag. 81)

025002
p. 149045073
p. 131

CROMATO

01-6309/5/1A-01

leva+ins. in finitura

€

01-6309/5/1A-66

leva+ins. bianco op.

€

01-6309/5/1A-67

leva+ins. nero op.

€

ALTRE FINITURE

XX-6309/5/1A-XX

leva+ins. in finitura €

XX-6309/5/1A-66

leva+ins. bianco op. €

XX-6309/5/1A-67

leva+ins. nero op. €

6301/6

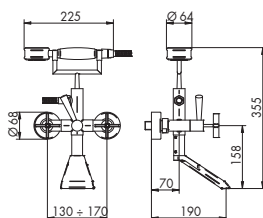

GRUPPO VASCA ESTERNO

- > vitone ceramico 90°
- > uscita libera senza areatore
- > interasse bocca 190
- > deviatore manuale senza ritorno automatico (vedi pag. 81)
- > doccetta monogetto in metallo (vedi pag. 81)
- > flessibile in metallo 150 cm
- > attacchi da 1/2"
- > maniglia a croce

605007
p. 151

CROMATO

01-6301/6-01

ins. in finitura

€

01-6301/6-66

ins. bianco op.

€

01-6301/6-67

ins. nero op.

€

ALTRE FINITURE

XX-6301/6-XX

ins. in finitura €

XX-6301/6-66

ins. bianco op. €

XX-6301/6-67

ins. nero op. €



6301/A

MISCELATORE VASCA ESTERNO

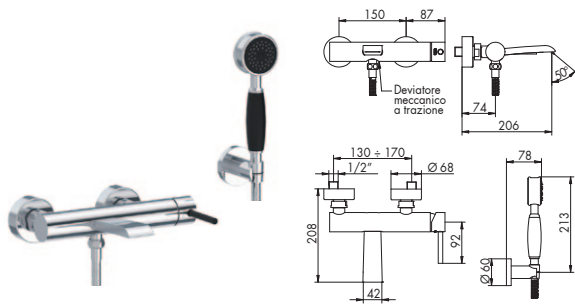

- > cartuccia tradizionale
- > uscita libera senza areatore > interasse bocca 206
- > deviatore a trazione/spinta senza ritorno automatico
- > doccetta monogetto in metallo (vedi pag. 81)
- > flessibile in metallo 150 cm
- > gancio a parete fisso > attacchi da 1/2"
- > leva a stilo (vedi pag. 81)

	025002 p. 149
	654020 p. 132

CROMATO

01-6301/A-01	leva+ins. in finitura	€
01-6301/A-66	leva+ins. bianco op.	€
01-6301/A-67	leva+ins. nero op.	€

ALTRE FINITURE

XX-6301/A-XX	leva+ins. in finitura	€
XX-6301/A-66	leva+ins. bianco op.	€
XX-6301/A-67	leva+ins. nero op.	€

6301/2/M

BATTERIA PER BORDO VASCA

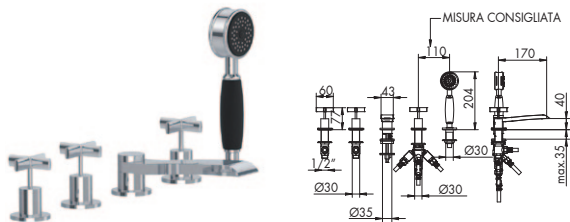

- > vitone ceramico 90°
- > uscita libera senza areatore > interasse bocca 170
- > deviatore a dischi ceramici 2 uscite senza chiusura
- > doccetta monogetto in metallo (vedi pag. 81)
- > flessibile in metallo 150 cm
- > senza scarico
- > maniglia a croce
- > PREDISPOSIZIONI per bordo vasca, art. 012/5, 012/6 e 012/7, vedi pag. 615

	605007 p. 151
--	-------------------------

CROMATO

01-6301/2/M-01	ins. in finitura	€
01-6301/2/M-66	ins. bianco op.	€
01-6301/2/M-67	ins. nero op.	€

ALTRE FINITURE

XX-6301/2/M-XX	ins. in finitura	€
XX-6301/2/M-66	ins. bianco op.	€
XX-6301/2/M-67	ins. nero op.	€

6301/2/A

MISCELATORE PER BORDO VASCA



- > cartuccia tradizionale
- > uscita libera senza areatore > interasse bocca 170
- > deviatore a pressione c/ritorno automatico e blocco meccanico bassa pressione
- > doccetta monogetto in metallo (vedi pag. 81)
- > flessibile in metallo 150 cm > flessibili di alimentazione
- > senza scarico
- > leva a stilo (vedi pag. 81)
- > PREDISPOSIZIONI per bordo vasca, art. 012/4, 012/6 e 012/7, vedi pag. 615

	025002 p. 149
	724030 p. 132

CROMATO

01-6301/2/A-01	leva+ins. in finitura	€
01-6301/2/A-66	leva+ins. bianco op.	€
01-6301/2/A-67	leva+ins. nero op.	€

ALTRE FINITURE

XX-6301/2/A-XX	leva+ins. in finitura	€
XX-6301/2/A-66	leva+ins. bianco op.	€
XX-6301/2/A-67	leva+ins. nero op.	€

6301/26

GRUPPO VASCA C/RACCORDI A PAVIMENTO

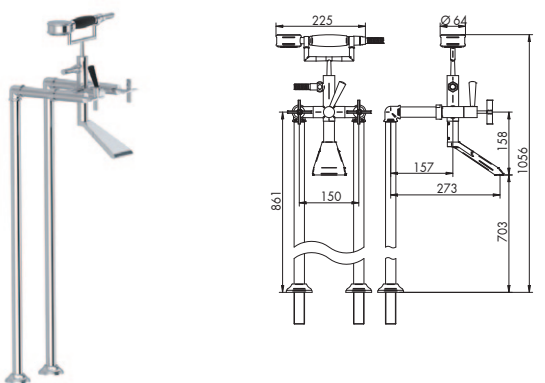

- > vitone ceramico 90°
- > uscita libera senza areatore
- > interasse bocca 273
- > deviatore manuale senza ritorno automatico (vedi pag. 81)
- > doccetta monogetto in metallo (vedi pag. 81)
- > flessibile in metallo 150 cm
- > attacchi da 3/4"
- > maniglia a croce
- > PREDISPOSIZIONI per gruppo vasca c/raccordi a pavimento, art. 054062, vedi pag. 734

	605007 p. 151
--	-------------------------

CROMATO

01-6301/26-01	ins. in finitura	€
01-6301/26-66	ins. bianco op.	€
01-6301/26-67	ins. nero op.	€

ALTRE FINITURE

XX-6301/26-XX	ins. in finitura	€
XX-6301/26-66	ins. bianco op.	€
XX-6301/26-67	ins. nero op.	€

6303

BOCCA VASCA DA PARETE

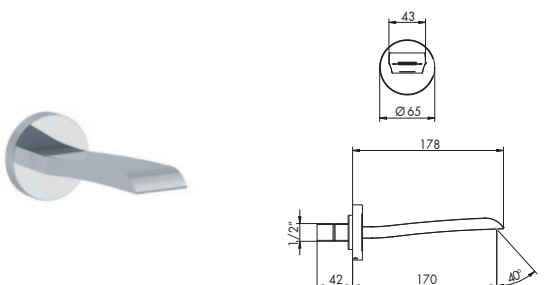

- > uscita libera senza areatore
- > interasse bocca 170
- > attacchi da 1/2"

CROMATO

01-6303	€
---------	---

ALTRE FINITURE

XX-6303	€
---------	---

RICAMBI IMMEDIATI



XX = CODICE FINITURA RICHIESTA: per identificare codice corretto vedi pag. 80
M* = MOLTIPLICATORE: per calcolare il prezzo delle altre finiture vedi tabella pag. 80

6308/ME + 604003 DX

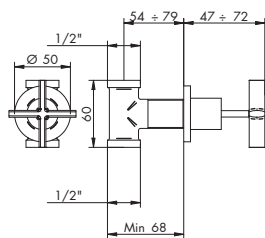

RUBINETTO D'ARRESTO 1/2"

- > vitone ceramico 90°
- > maniglia a croce
- > ingressi da 1/2"

 605007
p. 151

PARTI ESTERNE - CROMATO	
01-6308/ME	€
PARTE INCASSO	
604003	info pag. 41 €
PREZZO TOTALE	
	€

PARTI ESTERNE - ALTRE FINITURE	
XX-6308/ME	€

6308/ME + 604005 DX

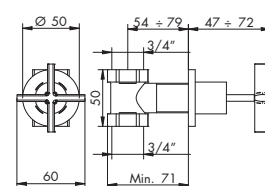

RUBINETTO D'ARRESTO 3/4"

- > vitone ceramico 90°
- > maniglia a croce
- > ingressi da 3/4"

 605007
p. 151

PARTI ESTERNE - CROMATO	
01-6308/ME	€
PARTE INCASSO	
604005	info pag. 41 €
PREZZO TOTALE	
	€

PARTI ESTERNE - ALTRE FINITURE	
XX-6308/ME	€

6308/E + 054025 DX o 054026 SX

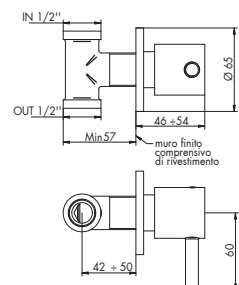

RUBINETTO D'ARRESTO 1/2"

- > vitone ceramico 90°
- > leva a stilo (vedi pag. 81)
- > ingressi da 1/2"

 055001
p. 151

 055002
p. 151

PARTI ESTERNE - CROMATO	
01-6308/E-01	leva in finitura €
01-6308/E-66	leva bianco op. €
01-6308/E-67	leva nero op. €
PARTE INCASSO	
054025/054026	info pag. 40 €
PREZZO TOTALE	
	€

PARTI ESTERNE - ALTRE FINITURE	
XX-6308/E-XX	leva in finitura €
XX-6308/E-66	leva bianco op. €
XX-6308/E-67	leva nero op. €

6308/E + 054027 DX o 054028 SX



RUBINETTO D'ARRESTO 3/4"

- > vitone ceramico 90°
- > leva a stilo (vedi pag. 81)
- > ingressi da 3/4"

 055001
p. 151

 055002
p. 151

PARTI ESTERNE - CROMATO	
01-6308/E-01	leva in finitura €
01-6308/E-66	leva bianco op. €
01-6308/E-67	leva nero op. €
PARTE INCASSO	
054027/054028	info pag. 40 €
PREZZO TOTALE	
	€

PARTI ESTERNE - ALTRE FINITURE	
XX-6308/E-XX	leva in finitura €
XX-6308/E-66	leva bianco op. €
XX-6308/E-67	leva nero op. €

